

Inductive sensor NCN3-F31-B3B-V1-V1

- Direct mounting on standard actuators
- A/B node with extended addressing possibility for up to 62 nodes
- Mode of operation, programmable
- Degree of protection IP67
- Communication monitoring, turn-off
- Lead breakage and short-circuit monitoring of the valve

Valve positioner and valve control module



Dimensions

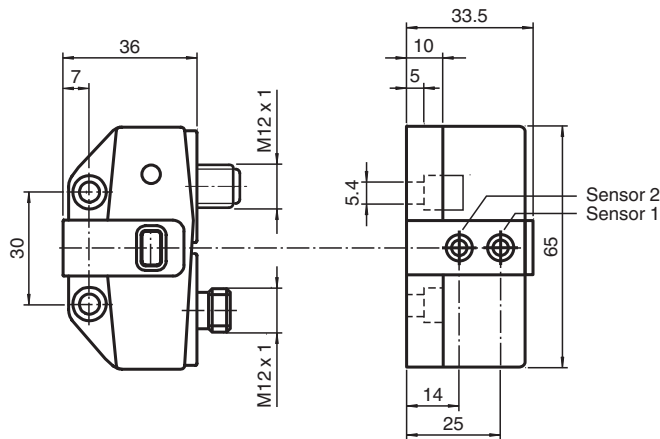

Drawing without actuator

Technical Data

General specifications		
Switching function		Normally open/closed (NO/NC) programmable
Output type		AS-Interface
Rated operating distance	s_n	3 mm
Installation		flush mountable
Assured operating distance	s_a	0 ... 2.43 mm
Reduction factor r_{AI}		0.5
Reduction factor r_{Cu}		0.45
Reduction factor r_{304}		1
Reduction factor r_{St37}		1.2
Node type		A/B node
AS-Interface specification		V3.0
Required gateway specification		\geq V2.1
Nominal ratings		
Operating voltage	U_B	26.5 ... 31.9 V via AS-i bus system
Switching frequency	f	0 ... 100 Hz
No-load supply current	I_0	\leq 35 mA

Release date: 2022-05-23 Date of issue: 2022-05-23 Filename: 226325_eng.pdf

Refer to "General Notes Relating to Pepperl+Fuchs Product Information".

Pepperl+Fuchs Group
www.pepperl-fuchs.com

USA: +1 330 486 0001
fa-info@us.pepperl-fuchs.com

Germany: +49 621 776 1111
fa-info@de.pepperl-fuchs.com

Singapore: +65 6779 9091
fa-info@sg.pepperl-fuchs.com

PEPPERL+FUCHS

Technical Data

Functional safety related parameters		
MTTF _d		842 a
Mission Time (T _M)		20 a
Diagnostic Coverage (DC)		0 %
Indicators/operating means		
LED PWR		AS-Interface voltage; LED green
LED IN		switching state (input); LED yellow
LED OUT		binary LED yellow/red yellow: switching state red: lead breakage/short-circuit
Electrical specifications		
Rated operating voltage	U _e	26.5 ... 31.6 V from AS-Interface
Rated operating current	I _e	100 mA
Compliance with standards and directives		
Standard conformity		
Electromagnetic compatibility		EN 50295:1999-10
Standards		EN 60947-5-2:2007 EN 60947-5-2/A1:2012 IEC 60947-5-2:2007 IEC 60947-5-2 AMD 1:2012
Approvals and certificates		
UL approval		cULus Listed, General Purpose
CSA approval		cCSAus Listed, General Purpose
CCC approval		CCC approval / marking not required for products rated ≤36 V
Ambient conditions		
Ambient temperature		-25 ... 70 °C (-13 ... 158 °F)
Mechanical specifications		
Connection (system side)		4-pin, M12 x 1 connector
Connection (valve side)		socket connector , M12 x 1 , 4-pin
Connector housing		metal
Housing material		PBT
Degree of protection		IP67
Tightening torque, fastening screws		4 Nm ... 5 Nm
Note		valve voltage limited to 26,4 V max.; valve power 2,5 W max.

Connection

B3B-V1-V1-Y

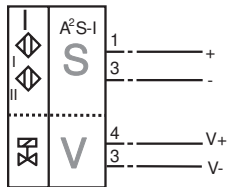

Connection Assignment

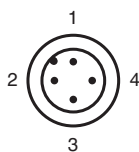

Assembly

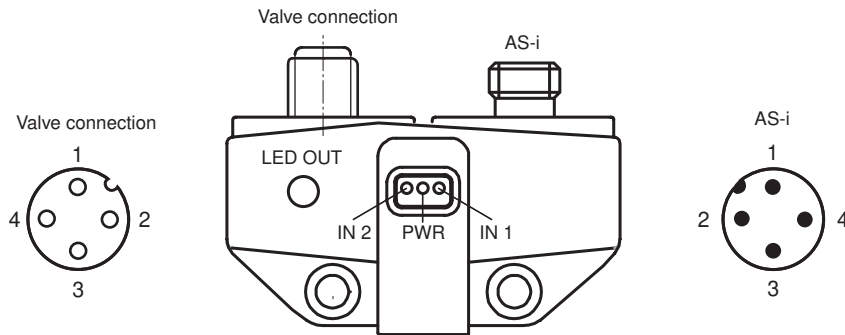

Additional Information

Programming Instructions

Address	00 preset, alterable via Busmaster or programming units
IO-code	D
ID-code	A
ID1-code	7
ID2-code	E

Data bit

Bit	Function
D0	valve status (0=valve OFF, 1=valve ON)
D1	valve fault ¹⁾ (0=lead breakage/short circuit; 1=no fault)
D2	switch output sensor 1 ²⁾ (0=damped; 1=undamped)
D3	switch output sensor 2 ²⁾ (0=damped; 1=undamped)

Parameter bit



Bit	Function
P0	Watchdog (0=inactive; 1=active) ³⁾
P1	switching element function sensor II ⁴⁾ 0=NO; 1= NC
P2	switching element function sensor I ⁴⁾ 0=NO; 1= NC
P3	not used

- 1) Verification only with actuated valve (D0=1)
- 2) Applies to NC function (P1/P2=1; preset), with NO function (P1/P2=0) reversed characteristics
- 3) Watchdog active: valve voltage drops with the occurrence of an AS-I communication fault

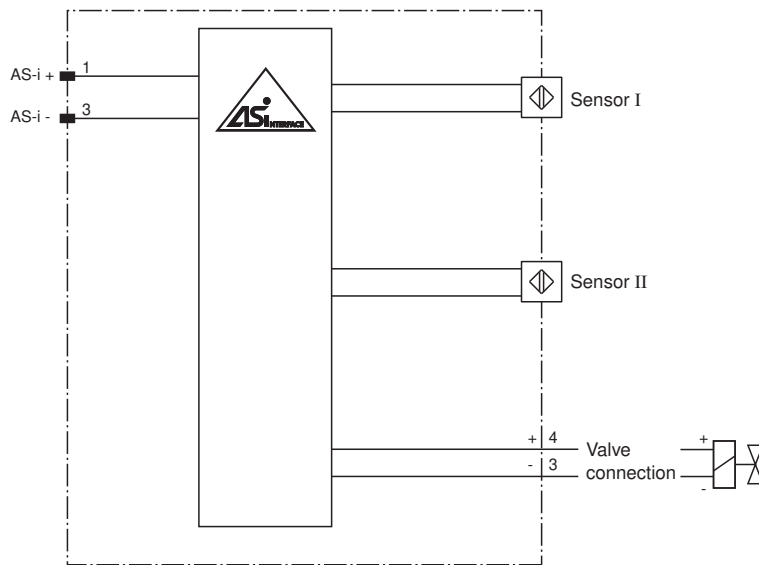





Mounting



Matching System Components

	BT115A	Activator for F31 series
	BT115X	Activator for F31 series

Accessories

	BT65B	Activator for F31 series
	BT115B	Activator for F31 series
	V1-W-2M-PUR	Female cordset single-ended M12 angled A-coded, 4-pin, PUR cable grey
	V1-G-2M-PUR	Female cordset single-ended M12 straight A-coded, 4-pin, PUR cable grey
	BT65A	Activator for F31 series
	BT65X	Activator for F31 series

Release date: 2022-05-23 Date of issue: 2022-05-23 Filename: 226325_eng.pdf

Function

The NCN3-F31-B3B-V1-V1 is an inductive dual sensor used to indicate the valve positioning of actuators. The dual sensor is mounted directly on the actuator using two screws. Additional adjustment is not necessary.

A switch box M12 x 1 on the sensor is used directly for the valve controls. The NCN3-F31-B3B-V1-V1 is connected via a M12x1 screw fixing to the bus line. This makes it possible to transmit both the switch signal for the valve and the messages of the sensors via AS-Interface. They are both powered directly through the bus cable. Moreover, the valve is monitored for lead breakage and short circuit. The D1 data bit monitors the fault signal.

The sensors can be programmed as normally closed and normally open contacts (parameter bit P1 and P2). If there are no communications on the bus cable, the valve is automatically de-energised. This communication monitoring can be turned off via the parameter bit P0.

The current switching states are displayed by means of yellow LEDs.